







Price list **Electric radiators**

05/2011

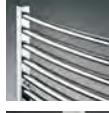

electric radiators

	Menai D E.....	4
	Menai E.....	6
	Likoma H E.....	8
	Likoma V E.....	10
	Delta Laserline E.....	12
	Apolima E.....	13
	Elato E.....	14
	Elato E T.....	15
	Muna E.....	16
	Muna E T.....	17
	Java E.....	18
	Minorca E.....	19
	Flores E.....	20

	Flores E T.....	21
	Flores CH E.....	22
	Flores C E.....	23
	Flores C CH E.....	24
	Alif E.....	25
	Amirante E.....	26
	Cosmoledo E.....	26

controls	27
-----------------------	----

accessories	28
--------------------------	----

colours	29
----------------------	----

general	30
----------------------	----

D = digital
 E = electric
 V = vertical
 H = horizontal
 T = turbo
 CH = chrome

Menai D E



- Smooth fronts that are easy to clean.
 - Decorative grid and side panels.
 - Manufactured in anti-corrosive, shock-proof, undeformable Swedish steel.
 - Unalterable epoxy paint, prevents yellowing.
 - Only available in RAL 9010 white.
 - Locking system to prevent uncoupling of brackets.
 - Quiet, odourless and anti-allergic.
 - Electric locking system for controls.
-
- Electronic thermostat : fast heating response and homogenous temperature distribution across the entire surface of the appliance.
 - Multifunctional and programmable control box with pilot wire – 2 orders (comfort, and night reduction with external clock).
 - Override «Low» and «Comfort» function for an unlimited period of time.
 - «Low» can be adjusted between 5°C and the confort temperature.



Menai D E



display screen
activated functions

- ☀ comfort
- ☾ low
- 🕒 programme menu external clock
- ❄ frost-free
- ↺ reset

choice of functions / temperature adjustment (+/-)

on / off

lock / unlock programme menu

validate choice

design: clean esthetic adapted to all interiors, rounded shapes.
no projecting angles

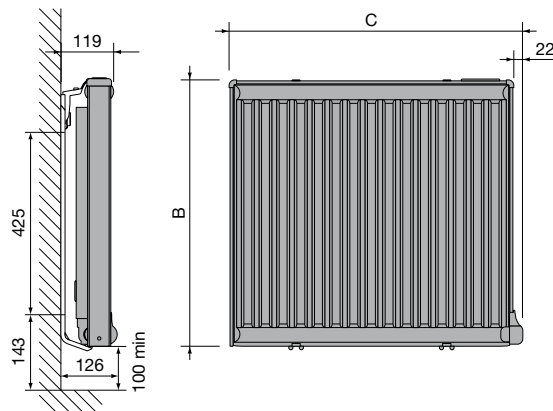

Dimensions in mm

type	B	C	weight (kg)	power (Watt)	€
MED600465EL	600	465	15,00	500	588,23
MED600625EL	600	625	20,50	800	648,19
MED600745EL	600	745	24,00	1000	679,66
MED600865EL	600	865	28,00	1200	722,13
MED6001105EL	600	1105	35,50	1600	834,53
MED6001385EL	600	1385	44,00	2000	923,66

stock Radson

B = height C = length

Menai E



- Smooth panels that are easy to clean.
- Decorative grid and side panels.
- Manufactured in anti-corrosive, shock-proof, undeformable Swedish steel.
- Unalterable epoxy paint, prevents yellowing.
- Only available in RAL 9010 white.

- Low surface temperature.
- Lock on control box.
- Protective polycarbonate (unbreakable) cover on control box.
- Easy to use, fast heating response and homogenous temperature distribution across the entire surface of the appliance.
- Multifunctional and programmable control box with pilot wire – 2 orders (comfort, and night reduction with external clock).



Menai E



single panel

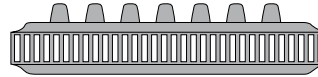

double panel

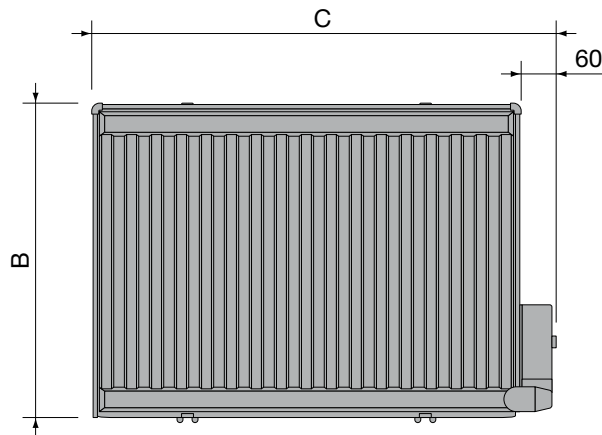
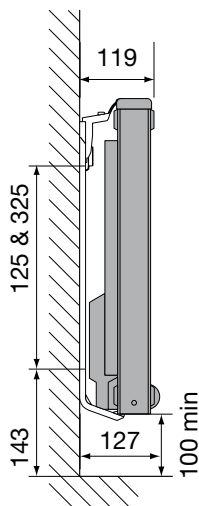

Dimensions in mm

type	B	C	weight (kg)	power (Watt)	€
ME300700EL	300	700	12,00	500	463,43
ME300980EL	300	980	17,00	800	529,51
ME3001180EL	300	1180	21,00	1000	575,16
ME3001420EL	300	1420	25,00	1200	612,48
ME3001940EL	300	1940	33,00	1600	705,67
ME3002340EL	300	2340	39,00	2000	865,57
ME500420EL	500	420	10,00	500	464,18
ME500620EL	500	620	16,00	800	513,24
ME500780EL	500	780	21,00	1000	554,22
ME500900EL	500	900	24,00	1200	587,64
ME5001180EL	500	1180	32,00	1600	660,27
ME5001420EL	500	1420	38,00	2000	731,14

stock Radson

B = height C = length

Likoma H E



I.P. 32
PROCESS
ISO 9001
ISO 14001



- Easy to maintain full and smooth horizontal panel.
- Ultra-flat (66 mm installed).
- Silent, odourless, and anti-allergic.
- Granite resin.
- Comes in 4 finishes : granite, sand, black and white.
- Elegance and clean lines : the thermostat has been placed at the back of the panel.
- Multifunctional and programmable control box with pilot wire – 2 orders (comfort, and night reduction with external clock).
- Programming of integrated “Low” (5, 7 or 12 hours).
- Easy to use, fast heating response and homogenous temperature distribution across the entire surface of the appliance.
- Low surface temperature.



Likoma H E

Likoma H E comes in four different finishes :



SG = sand
WG = white
GG = granite
BG = black

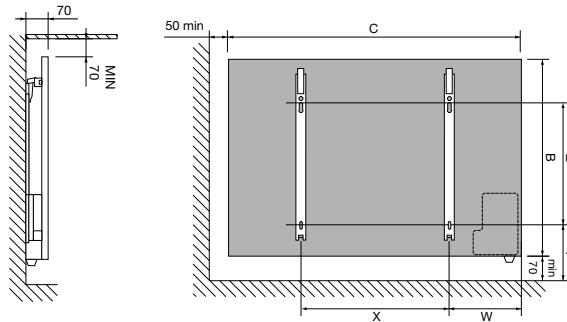

Dimensions in mm

type	B	C	weight (kg)	power (Watt)		€
				n	e	
LIH600400ELGG	600	400	8,00	400	260	660,76
LIH600400ELSG	600	400	8,00	400	260	660,76
LIH600400ELWG	600	400	8,00	400	260	660,76
LIH600400ELBG	600	400	8,00	400	260	700,22
LIH600600ELGG	600	600	11,00	600	390	717,12
LIH600600ELSG	600	600	11,00	600	390	717,12
LIH600600ELWG	600	600	11,00	600	390	717,12
LIH600600ELBG	600	600	11,00	600	390	757,45
LIH600800ELGG	600	800	15,00	800	520	793,20
LIH600800ELSG	600	800	15,00	800	520	793,20
LIH600800ELWG	600	800	15,00	800	520	793,20
LIH600800ELBG	600	800	15,00	800	520	834,04
LIH6001000ELGG	600	1000	19,00	1000	650	856,60
LIH6001000ELSG	600	1000	19,00	1000	650	856,60
LIH6001000ELWG	600	1000	19,00	1000	650	856,60
LIH6001000ELBG	600	1000	19,00	1000	650	897,45
LIH6001200ELGG	600	1200	22,00	1200	780	908,74
LIH6001200ELSG	600	1200	22,00	1200	780	908,74
LIH6001200ELWG	600	1200	22,00	1200	780	908,74
LIH6001200ELBG	600	1200	22,00	1200	780	948,17

stock Radson

B = height C = length n = nominal heat output e = effectif heat output

Likoma V E



- Easy to maintain full and smooth vertical panel.
- Ultra-flat (66 mm installed).
- Silent, odourless, and anti-allergic.
- Granite resin.
- Comes in 4 finishes : granite, sand, black and white.
- Elegance and clean lines : the thermostat has been placed at the back of the panel.
- Multifunctional and programmable control box with pilot wire – 2 orders (comfort, and night reduction with external clock).
- Programming of integrated “Low” (5, 7 or 12 hours).
- Easy to use, fast heating response and homogenous temperature distribution across the entire surface of the appliance.
- Low surface temperature.



Likoma V E

Likoma V E comes in 4 finishes :

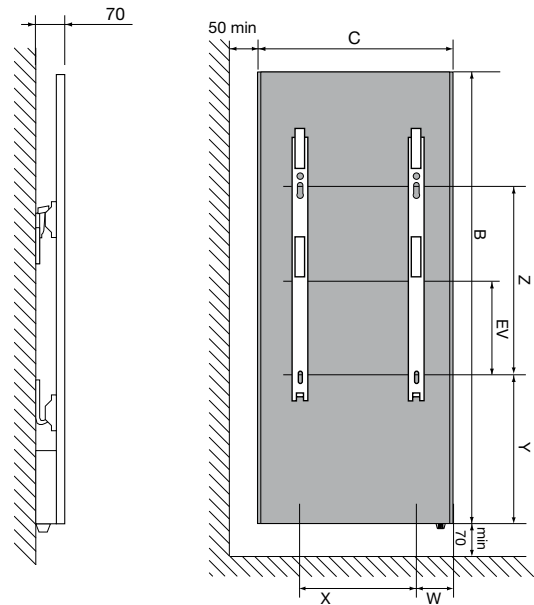
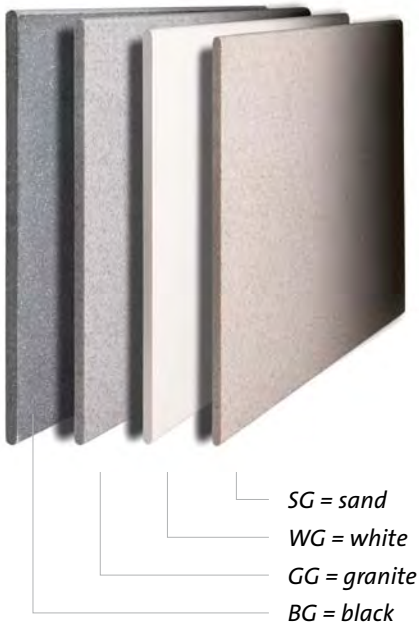

Dimensions in mm

type	B	C	weight (kg)	n	e (Watt)	€
LIV900400ELGG	900	400	11,00	600	390	762,21
LIV900400ELSG	900	400	11,00	600	390	762,21
LIV900400ELWG	900	400	11,00	600	390	762,21
LIV900400ELBG	900	400	11,00	600	390	797,42
LIV1500400ELGG	1500	400	19,00	1000	650	865,05
LIV1500400ELSG	1500	400	19,00	1000	650	865,05
LIV1500400ELWG	1500	400	19,00	1000	650	865,05
LIV1500400ELBG	1500	400	19,00	1000	650	905,90
LIV1800400ELGG	1800	400	22,00	1200	780	924,21
LIV1800400ELSG	1800	400	22,00	1200	780	924,21
LIV1800400ELWG	1800	400	22,00	1200	780	924,21
LIV1800400ELBG	1800	400	22,00	1200	780	943,95
LIV1500600ELGG	1500	600	27,00	1500	975	963,67
LIV1500600ELSG	1500	600	27,00	1500	975	963,67
LIV1500600ELWG	1500	600	27,00	1500	975	963,67
LIV1500600ELBG	1500	600	27,00	1500	975	1003,13
LIV1800600ELGG	1800	600	32,00	1800	1170	1029,89
LIV1800600ELSG	1800	600	32,00	1800	1170	1029,89
LIV1800600ELWG	1800	600	32,00	1800	1170	1029,89
LIV1800600ELBG	1800	600	32,00	1800	1170	1070,75

stock Radson

B = height C = length n = nominal heat output e = effectif heat output

Delta Laserline E

CE  I.P. 34
 Classe II PROCESS ISO 9001 ISO 14001



- Tubular electric radiator (3 columns) and heating medium liquid.
- Entirely laser-welded.
- Multifunctional and programmable control box with pilot wire – 2 orders (comfort, and night reduction with external clock).
- Width of one tube (element) : 50 mm.
- Inalterable white epoxy paint, prevents yellowing.
- Only available in white, RAL 9016.
- Angle wall brackets included in the packaging.

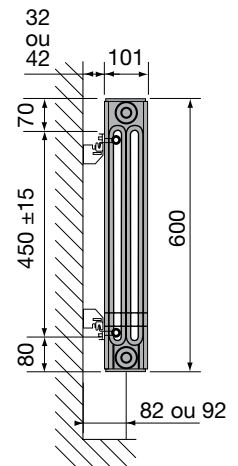
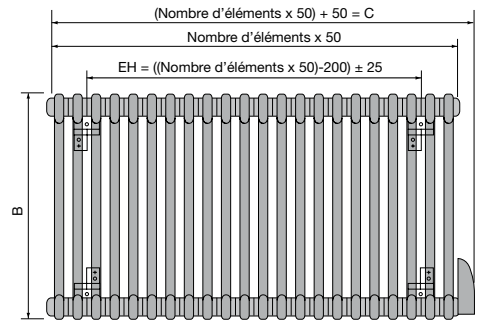

Dimensions in mm

type	B	C	weight (kg)	number of elements	power (Watt)	€
DL0604EL	600	450	22,00	8	500	450,19
DL0605EL	600	550	27,00	10	750	53,,42
DL0606EL	600	650	32,00	12	1000	582,60
DL0607EL	600	750	37,00	14	1250	691,04
DL0609EL	600	900	46,00	17	1500	749,05
DL0611EL	600	1150	58,00	22	2000	912,98

stock Radson

B = height C = length



Thanks to its original totem shape, the Apolima lends an original touch to your home.

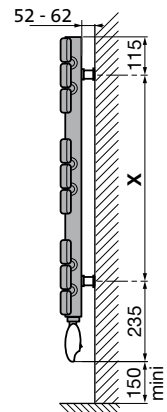
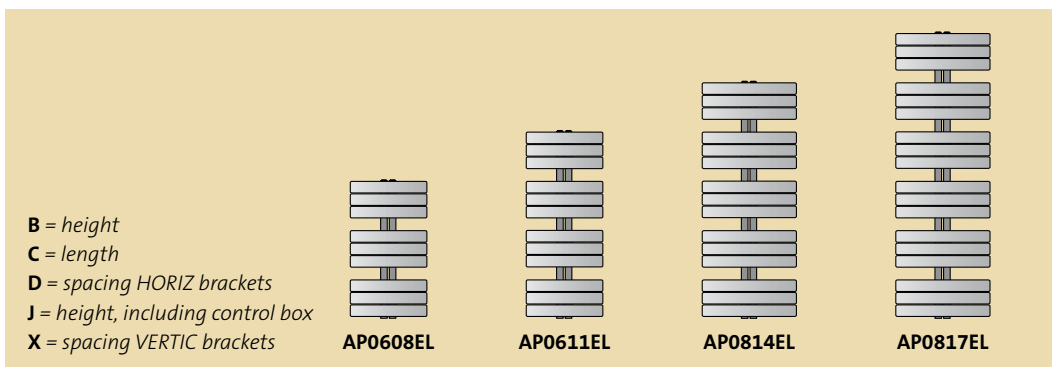

- Accessories in packaging and included in the price : brackets.
- Assembly : 2 fixing elements have been welded to the back of the appliance for 2 adjustable wall consoles.
- Colours : standard colour is RAL 9016 white.
Other available colours : see page 29.
- Comes with an infrared clock thermostat : see page 27.
- Accessories : see page 28.

Dimensions in mm



type	B	C	D	J	X	weight (kg)	power (Watt)	€
AP0608EL	830	650	50	950	600	22,00	500	1010,24
AP0611EL	1130	650	50	1250	900	24,40	750	1133,60
AP0814EL	1430	800	50	1550	1200	29,20	1000	1218,42
AP0817EL	1730	800	50	1850	1500	41,10	1250	1349,53

Elato E

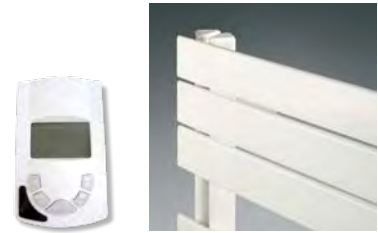

 - IP44 - IK 09 - 
 classe II



The Elato stands out because of its airy linear design.

- Accessories in packaging and included in the price :brackets.
- Assembly : 2 fixing elements have been welded to the back of the appliance for 2 adjustable wall consoles.
- Colours : standard colour is RAL 9016 white. Other available colours : see page 29.
- Comes with an infrared clock thermostat : see page 27.
- Accessories : see page 28.

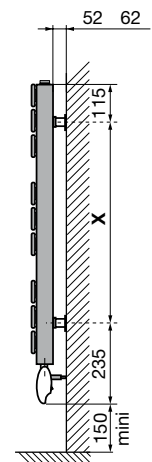
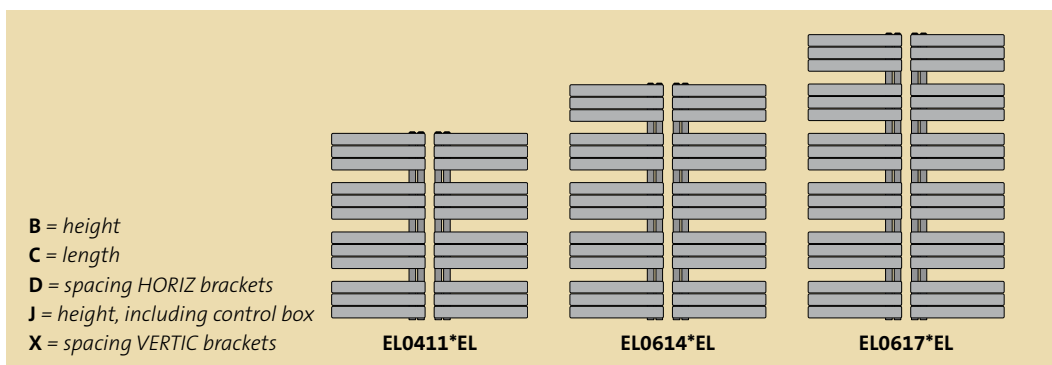
Dimensions in mm



type	B	C	D	J	X	weight (kg)	power (Watt)	€
EL0411*EL	1130	450	50	1250	900	17,80	500	762,70
EL0614*EL	1430	600	50	1550	1200	28,70	750	850,64
EL0617*EL	1730	600	50	1850	1500	35,20	1000	996,23

stock Radson in R version (right)

Replace * with "R" for right-hand vertical collectors, and with "L" for left-hand vertical collectors.



The integrated Turbo at the bottom of towel warmer radiators provides additional heating in your bathroom to ensure a rapid rise in temperature at all times during the day. This intelligent solution combines the benefits of a towel warmer radiator with the rapid heating response of the Turbo, for a perfectly heated bathroom throughout the year.

- Easy to use. Simply push the boost button on the control box, which will release a homogenous and silent flow of hot air, which will be diffused towards the ground, for more comfort. A luminous and discrete warning light will warn you that the Turbo is switched on.
- On/off button integrated on the blower.
- Maintenance signal lamp for the removable anti-dust filter.
- Accessories in packaging and included in the price : brackets.
- Assembly : 2 fixing elements have been welded to the back of the appliance for 2 adjustable wall consoles.
- Colours : standard colour is RAL 9016 white. Other available colours : see page 29.
- Comes with an infrared clock thermostat : see page 27.
- Accessoires : zie blz. 28.



Dimensions in mm

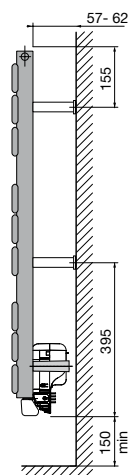
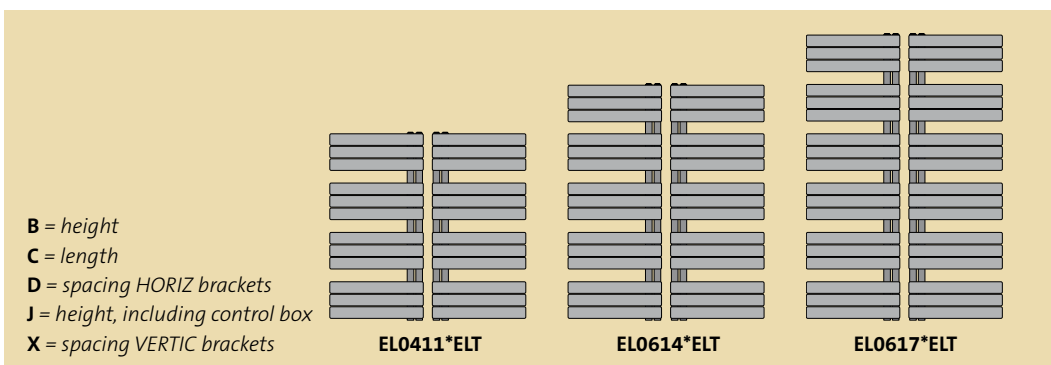

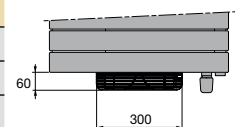

type	B	C	D	J	X	weight (kg)	power (Watt)	€
EL0411*ELT	1130	450	50	1185	900	17,80	500+1000	964,71
EL0614*ELT	1430	600	50	1485	1200	28,70	750+1000	1052,65
EL0617*ELT	1730	600	50	1785	1500	35,20	1000+1000	1198,24



stock Radson in R version (right)

Replace * with "R" for right-hand vertical collectors, and with "L" for left-hand vertical collectors.

Muna E



 - IP44 - IK 09 - 
 classe II



An elegant radiator with flat tubes, which are positioned on the collectors.

- Accessories provided in the packaging and included in the price : brackets.
- Assembly : 4 fixing elements have been welded to the back of the appliance for 4 adjustable wall consoles
- Colours : the standard colour is white, RAL 9016. Other available colours : see page 29.
- Comes with «control box + receiver» : see page 27.
- **Optional :**
«infrared clock thermostat» : see page 27.
- Accessories : see page 28.



Dimensions in mm

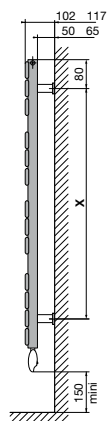
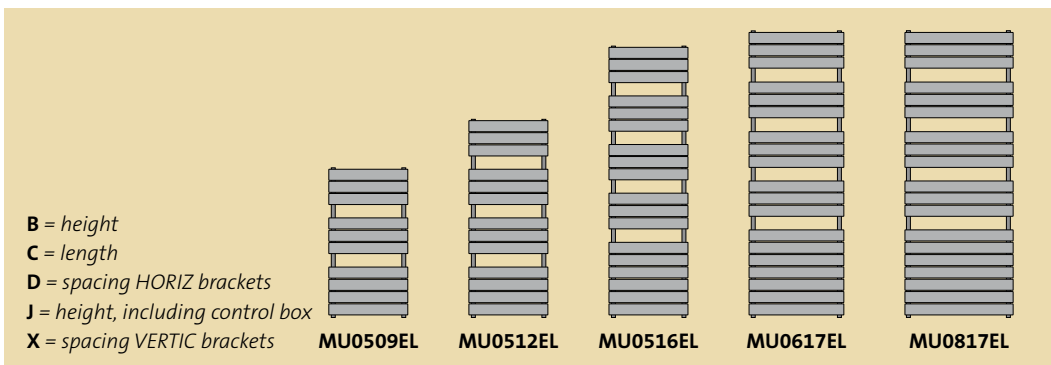

type	B	C	D	J	X	weight (kg)	power (Watt)	€
MU0509EL	905	500	438	1025	620	16,60	500	656,85
MU0512EL	1205	500	438	1325	990	21,50	750	752,77
MU0516EL	1655	500	438	1775	1460	28,20	1000	893,00
MU0617EL	1730	600	538	1850	1460	35,00	1250	1011,08
MU0817EL	1730	800	738	1850	1460	36,90	1500	1107,04

 stock Radson

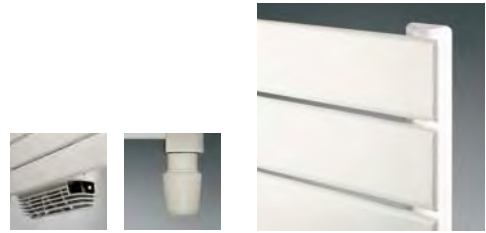

The integrated Turbo at the bottom of towel warmer radiators provides additional heating in your bathroom to ensure a rapid rise in temperature at all times during the day. This intelligent solution combines the benefits of a towel warmer radiator with the rapid heating response of the Turbo, for a perfectly heated bathroom throughout the year.

- Easy to use. Simply push the boost button on the control box, which will release a homogenous and silent flow of hot air, which will be diffused towards the ground, for more comfort. A luminous and discrete warning light will warn you that the Turbo is switched on.
- On/off button integrated on the blower.
- Maintenance signal lamp for the removable anti-dust filter.
- Accessories in packaging and included in the price :brackets.
- Assembly : 4 fixing elements have been welded to the back of the appliance for 4 adjustable wall consoles
- Colours : the standard colour is white, RAL 9016. Other available colours :see page 29.
- Comes with an infrared clock thermostat : see page 28.
- Accessories : see page 28.



Dimensions in mm

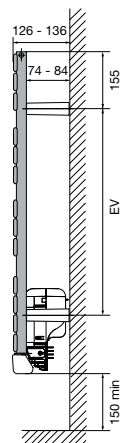
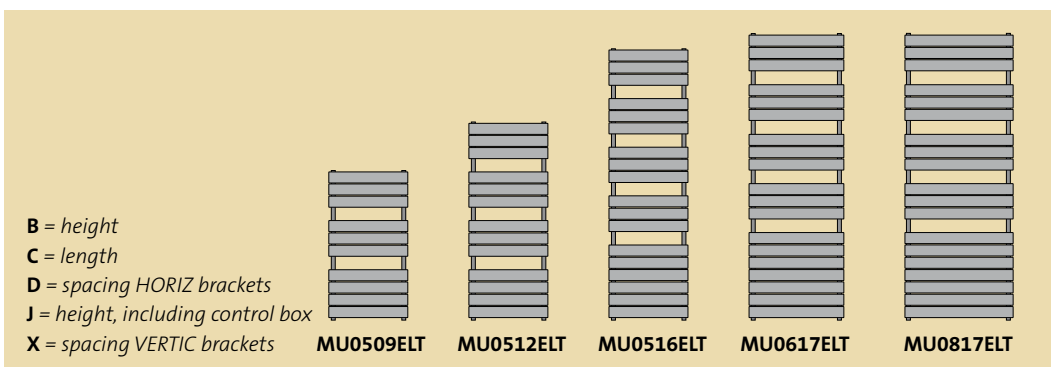

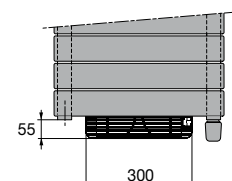

type	B	C	D	J	X	weight (kg)	power (Watt)	€
MU0509ELT	905	500	438	960	620	16,60	500+1000	858,86
MU0512ELT	1205	500	438	1260	990	21,50	750+1000	954,78
MU0516ELT	1655	500	438	1710	1460	28,20	1000+1000	1095,01
MU0617ELT	1730	600	538	1785	1460	35,00	1250+1000	1213,09
MU0817ELT	1730	800	738	1785	1460	36,90	1500+1000	1309,05



stock Radson

Java E



 - IP44 - IK 09 - 
 classe II



Tipped elliptical tubes contribute to the lightness of the design.

- Accessories provided in the packaging and included in the price : brackets.
- Assembly : 4 fixing elements have been welded to the back of the appliance for 4 adjustable wall consoles.
- Colours : the standard colour is white, RAL 9016. Other available colours : see page 29.
- Comes standard with «control box + receiver» : see page 27.
- **Optional :**
«infrared clock thermostat» : see page 27.



Dimensions in mm

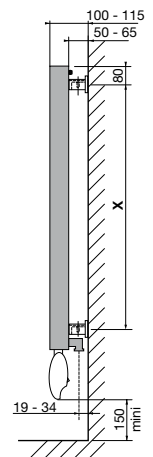
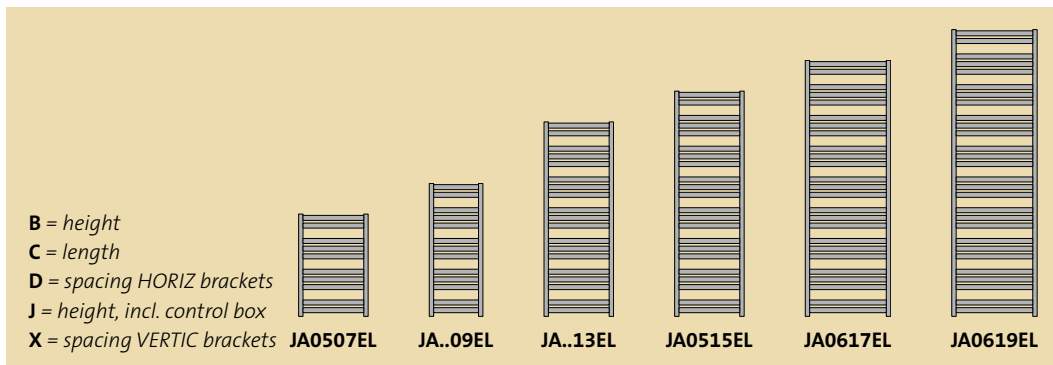

type	B	C	D	J	X	weight (kg)	power (Watt)	€
JA0507EL	700	500	470	820	520	11,80	350	560,71
JA0409EL	912	400	370	1032	750	12,70	400	589,05
JA0509EL	912	500	470	1032	750	15,70	500	613,35
JA0413EL	1336	400	370	1456	1170	17,70	600	670,50
JA0513EL	1336	500	470	1456	1170	20,50	750	729,41
JA0515EL	1548	500	470	1668	1320	23,00	1000	814,12
JA0617EL	1760	600	570	1880	1600	23,60	1250	887,32
JA0619EL	1972	600	570	2092	1790	32,40	1500	978,30

stock Radson



An elegant design with oval curved flat tubes.

- Accessories provided in the packaging and included in the price : brackets.
- Assembly : comes with 4 isolated adjustable wall consoles in between the tubes. The consoles are white. The consoles are always chromed for models in other colours.
- Colours : the standard colour is white, RAL 9016. Other available colours : see page 29.
- Comes standard with «control box + receiver» : see page 27
- **Optional :**
«infrared clock thermostat» : see page 27.



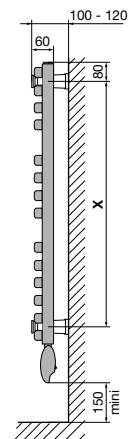
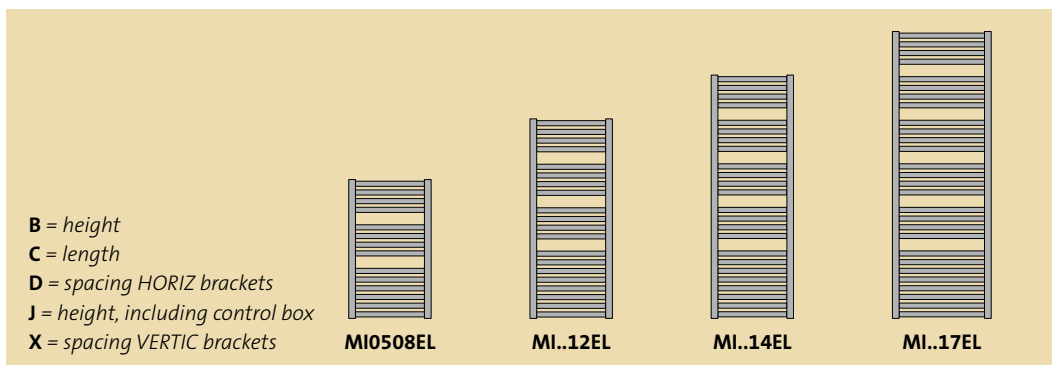

Dimensions in mm



type	B	C	D	J	X	weight (kg)	power (Watt)	€
MI0508EL	849	500	295	969	742	12,70	500	594,17
MI0512EL	1220	500	295	1340	1113	18,00	750	707,75
MI0517EL	1750	500	295	1870	1643	25,00	1000	776,54
MI0612EL	1220	600	395	1340	1113	21,60	750	828,16
MI0614EL	1485	600	395	1605	1378	25,40	1000	843,96
MI0617EL	1750	600	395	1870	1643	29,20	1250	861,52
MI0712EL	1220	750	545	1340	1113	32,40	1000	993,79
MI0714EL	1485	750	545	1605	1378	38,10	1250	1012,74
MI0717EL	1750	750	545	1870	1643	43,80	1500	1034,32

stock Radson

Flores E



 - IP44 - IK 09 -  CAT C
 classe II



Understated beauty for a radiator with slender round tubes.

- Accessories provided in the packaging and included in the price : brackets, mounted injection vent, screws and dowels.
- Assembly : comes with 3 isolated adjustable wall consoles in between the tubes. The consoles are white. The consoles are always chromed for models in other colours.
- Colours : the standard colour is white, RAL 9016. Other available colours : see page 29.
- Comes standard with «comfort mode» : see page 27.
- Accessories : see page 28.

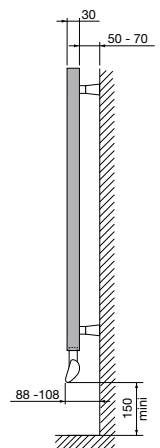
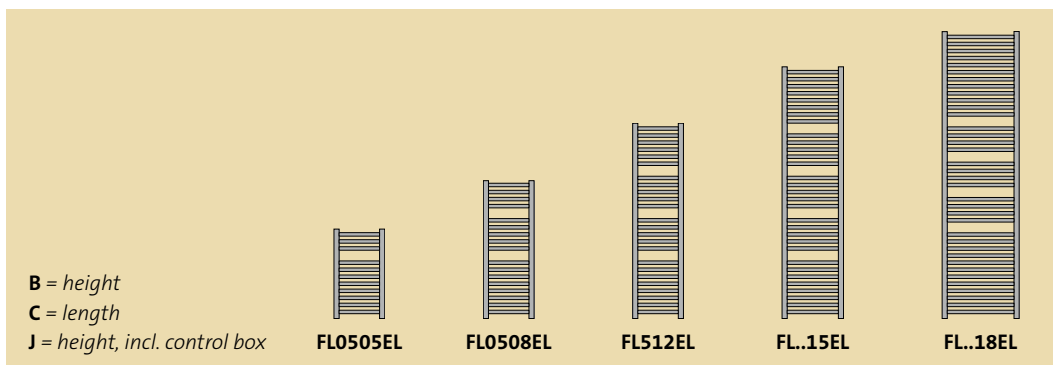
Dimensions in mm



type	B	C	J	weight (kg)	power (Watt)	€
FL0505EL	547	500	638	7,00	300	423,23
FL0508EL	862	500	953	10,50	500	443,81
FL0512EL	1222	500	1313	14,70	750	511,89
FL0615EL	1537	600	1628	21,20	1000	606,85
FL0715EL	1537	750	1628	26,00	1250	643,80
FL0518EL	1807	500	1898	20,30	1000	548,85
FL0618EL	1807	600	1898	25,00	1250	619,16
FL0718EL	1807	750	1898	29,60	1500	669,10

stock Radson



The integrated Turbo at the bottom of towel warmer radiators provides additional heating in your bathroom to ensure a rapid rise in temperature at all times during the day. This intelligent solution combines the benefits of a towel warmer radiator with the rapid heating response of the Turbo, for a perfectly heated bathroom throughout the year.

- Easy to use. Simply push the boost button on the control box, which will release a homogenous and silent flow of hot air, which will be diffused towards the ground, for more comfort. A luminous and discrete warning light will warn you that the Turbo is switched on.
- On/off button integrated on the blower.
- Maintenance signal lamp for the removable anti-dust filter.
- Accessories provided in the packaging and included in the price : brackets, mounted injection vent, screws and dowels.
- Assembly : comes with 3 isolated adjustable wall consoles in between the tubes. The consoles are white. The consoles are always chromed for models in other colours.
- Colours : the standard colour is white, RAL 9016. Other available colours : see page 29.
- Comes with an infrared clock thermostat : see page 27.
- Accessories : see page 28.



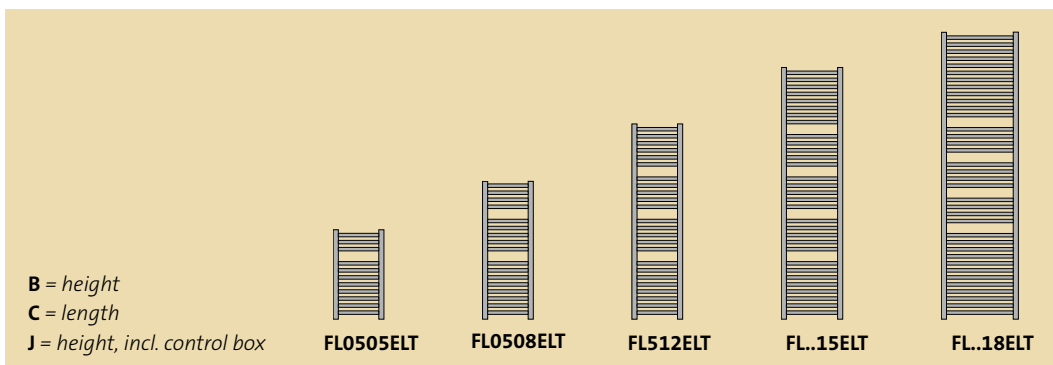

Dimensions in mm



type	B	C	J	weight (kg)	power (Watt)	€
FL0505ELT	547	500	602	7,00	300+1000	625,24
FL0508ELT	862	500	917	10,50	500+1000	645,82
FL0512ELT	1222	500	1277	14,70	750+1000	713,90
FL0615ELT	1537	600	1592	21,20	1000+1000	808,86
FL0715ELT	1537	750	1592	26,00	1250+1000	845,81
FL0518ELT	1807	500	1862	20,30	1000+1000	750,86
FL0618ELT	1807	600	1862	25,00	1250+1000	821,17
FL0718ELT	1807	750	1862	29,60	1500+1000	871,11

stock Radson

Flores CH E



 - IP44 - IK 09 - 
 classe II

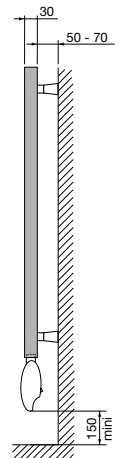
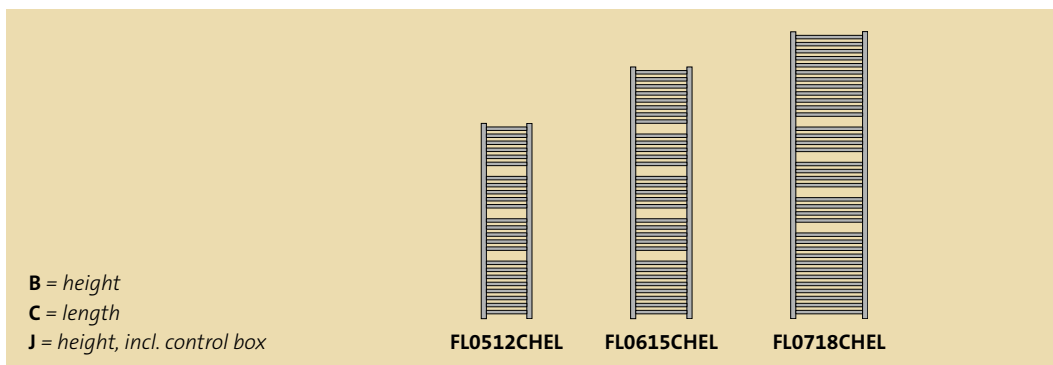

- Accessories provided in the packaging and included in the price : brackets, mounted injection vent, screws and dowels.
- Assembly : 3 isolated adjustable wall consoles in between the tubes. The consoles are chromed.
- Comes with an infrared clock thermostat : see page 27.

Dimensions in mm



type	B	C	J	weight (kg)	power (Watt)	€
FL0512CHEL	1222	500	1342	17,80	500	1068,56
FL0615CHEL	1537	600	1657	24,70	750	1446,56
FL0718CHEL	1807	750	1927	33,50	1000	1584,66



The Flores C is the curvier version of the Flores. Its slender tubes are integrated in the collectors.

- Accessories provided in the packaging and included in the price : brackets, mounted injection vent, screws and dowels.
- Assembly : comes with 4 isolated adjustable wall consoles in between the tubes. The consoles are white. The consoles are always chromed for models in other colours.
- Colours : the standard colour is white, RAL 9016. Other available colours : see page 29.
- Comes standard with «comfort mode» : see page 27.
- Accessories : see page 28.

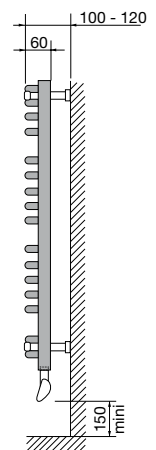
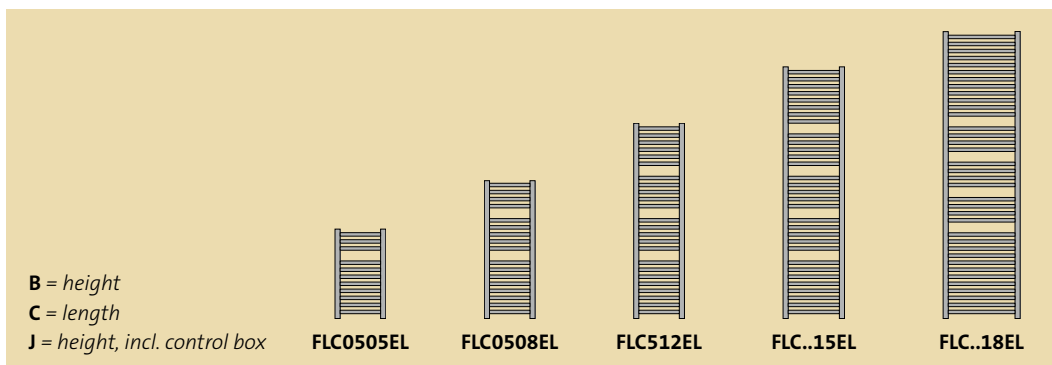

Dimensions in mm



type	B	C	J	weight (kg)	power (Watt)	€
FLC0505EL	547	500	638	6,90	300	492,34
FLC0508EL	862	500	953	10,40	500	529,08
FLC0512EL	1222	500	1313	14,70	750	617,82
FLC0615EL	1537	600	1628	21,10	1000	697,54
FLC0715EL	1537	750	1628	25,90	1250	718,52
FLC0518EL	1807	500	1898	20,30	1000	704,04
FLC0618EL	1807	600	1898	25,00	1250	730,03
FLC0718EL	1807	750	1898	29,60	1500	775,78

stock Radson

Flores C CH E



 - IP44 - IK 09 - 
 classe II



Flores C CH E is the chromed version of the Flores C E model. Its slender tubes are integrated in the collectors.

- Accessories provided in the packaging and included in the price : brackets, mounted injection vent, screws and dowels.
- Assembly : comes with 4 isolated adjustable wall consoles in between the tubes. The consoles are chromed.
- Comes with an infrared clock thermostat : see page 27.
- Accessories : see page 28.

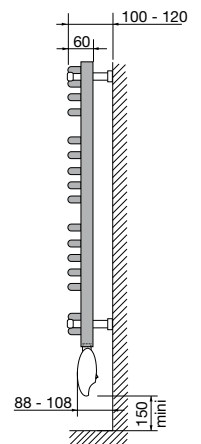
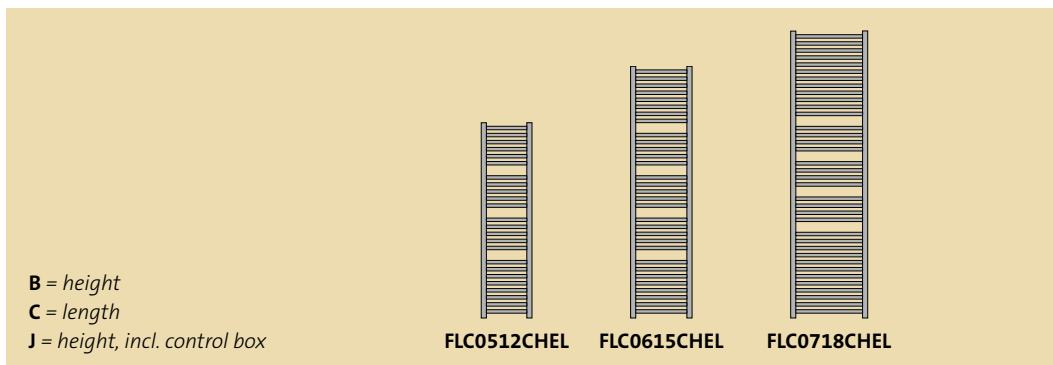
Dimensions in mm



type	B	C	J	weight (kg)	power (Watt)	€
FLC0512CHEL	1222	500	1342	17,80	500	1257,56
FLC0615CHEL	1537	600	1657	24,70	750	1730,04
FLC0718CHEL	1807	750	1927	33,50	1000	1860,88



- Electric steel towel warmer radiator
- Round horizontal tubes – diameter : 22 mm.
- Vertical collectors in D, 40 x 0 mm.
- Full surface treatment followed by protective electrophoresis baths.
- Plunger mounted in the factory, comes with luminous on/off button, a power cable and an electric socket.
- Heating medium liquid : glycol water.
- Colours : the standard colour is white, RAL 9016.
Other available colours : see page 29.

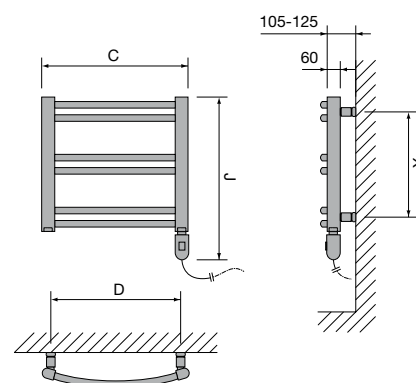

C = length
D = spacing **HORIZ** brackets
J = height, including control box
X = spacing **VERTIC** brackets

Dimensions in mm

type	C	D	J	X	number of tubes	power (Watt)	€
AL0505EL	500	440	550	360	6	80	179,70

stock Radson

Amirante E Cosmoledo E

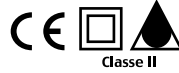

I.P. 44
PROCESS
ISO 9001
ISO 14001



- Electric steel towel warmer radiator.
- Swedish anti-corrosive, shockproof, undeformable steel.
- Bipolar on/off control box.
- Easy to mount : during installation you can choose whether you want to mount the appliance with the control box at the top or the bottom.



- 2 types of connection possible : recessed or apparent.
- Silent and odourless.
- Does not require adjusting.
- Low energy consumption : 50 to 70 Watt.
- Two colours : white or chromed.

Amirante E



Cosmoledo E

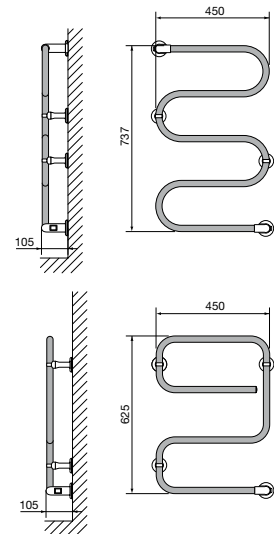

Dimensions in mm



type	B	C	weight (kg)	power (Watt)	€
AM0407CHEL	725	450	3,00	50	140,40
AM0407EL	725	450	3,00	65	115,32

type	B	C	weight (kg)	power (Watt)	€
CO0406CHEL	625	450	3,00	55	132,24
CO0406EL	625	450	3,00	70	112,29











stock Radson

B = height C = length

controls

Control box with integrated FM radio	Control box + receiver	Comfort function
		
<p>Standard on the : Elato E & ET, Apolima E, Muna ET, Flores ET Flores CH E, Flores C CH E</p>	<p>Standard on the : Muna E, Java E, Minorca E</p>	<p>Standard on the : Flores E & ET, Flores C E</p>
<p>Optional on : Muna E, Java E, Minorca E</p> <p style="text-align: right;">Price : € 138,39</p>		
<ul style="list-style-type: none"> • Transmitter with infrared connection • Digital reproduction of time and room temperature • Three programmes, programmed in advance and changeable • 'Holiday' option • Supplied by three enclosed LR06 batteries • Infrared receiver C category with on/off button: <ul style="list-style-type: none"> - Varnished in the colour of the apparatus for the shades Sanitaire and Argent no 27 (RAL9006) - In chromed finish for all other shades • Multifunctional programmable control box with pilot wire - 2 orders (comfort and night reduction with external clock) • Increased operation and/or adjustable ventilator 	<ul style="list-style-type: none"> • Infrared electronic wall thermostat with connection. • Override function with adjustable timer up to 2 hours <ul style="list-style-type: none"> - 2 time brackets for a daily repetitive cycle at a precise time of switching on override function by programming the 2-hr timer. • Battery-operated. Comes with 2 flat CR2430 batteries, 2 x 1,5 V AAA. • Infrared C-class receiver with on/off button : <ul style="list-style-type: none"> - in the colour of the appliance for bathroom colours and Silver n°27 (RAL9006) . - chrome finish for all other colours. • Multifunctional and programmable control box with pilot wire – 2 orders (comfort, and night reduction with external clock). 	<ul style="list-style-type: none"> • Electronic C-class thermostat with on/off button. • Override function with timer 2 hrs : <ul style="list-style-type: none"> - Comfort function : daily repetitive cycle at a precise time of switching on override function by programming the 2-hr timer. - can be switched on at all times. • Multifunctional and programmable control box with pilot wire – 2 orders (comfort, and night reduction with external clock).

accessories

	description	details	reference	€
	V-shaped knobs - per pair Elato E & ET, Muna E & ET, Apolima E	white	PATVPBL	21,19
		chrome	PATVPCH	21,19
	V-shaped knobs - per pair Flores E & ET, Flores C E	white	PATVRBL	17,21
		chrome	PATVRCH	17,21
	towel ring Elato E & ET, Muna E & ET, Apolima E	white	ANOPBL	47,67
		chrome	ANOPCH	47,67
	towel ring Flores E & ET, Flores C E	white	ANORBL	45,02
		chrome	ANORCH	45,02
	round knobs - per pair Flores E & ET, Flores C E	white	PATRBL	17,21
		chrome	PATRCH	17,21
	grill Flores E & ET width of radiator : min. 600 mm	white	GRILLBL	94,01
		chrome	GRILLCH	94,01
	towel bar Flores E & ET - straight 370 mm width of radiator min. 500 mm	white	BARR40BL	35,75
		chrome	BARR40CH	35,75
	towel bar Flores E & ET - straight 470 mm width of radiator min. 600 mm	white	BARR50BL	41,05
		chrome	BARR50CH	41,05
	towel bar straight 375 mm Elato E & ET, Muna E & ET	white	BARP40BL	43,69
		chrome	BARP40CH	43,69
	towel bar curved 370 mm Flores C E rad. width min. 500 mm	white	BARR40CBL	39,72
		chrome	BARR40CCH	39,72
	towel bar curved 470 mm Flores C E rad. width min. 600 mm	chrome	BARR50CBL	45,02
		white	BARR50CCH	45,02
	towel bar Delta E	white	D881-2125XX	128,99
		other colours	D881-2115XX XX=number of elements	147,43
	towel bar - Likoma H E 400 mm	width 570	LHDH400C	96,27
	feet - per pair Menai E	height 300	L3900110	71,52
	safety lock Menai E		L3990010	6,87
	stick of white paint	RAL 9016	L4950101	15,13

colours

Standard colour = RAL 9016.

Other available RAL colours. add at the order code /... and complete the RAL-colour.

Ex. K0H206001350/3003 for a radiator in RAL 3003.

15 % supplement

code Radson	Intern. RAL-code	code Radson	Intern. RAL-code	code Radson	Intern. RAL-code	code Radson	Intern. RAL-code
PP1000	RAL 1000	PP3027	RAL 3027	PP6019	RAL 6019	PP8004	RAL 8004
PP1001	RAL 1001	PP3031	RAL 3031	PP6020	RAL 6020	PP8007	RAL 8007
PP1002	RAL 1002	PP4001	RAL 4001	PP6021	RAL 6021	PP8008	RAL 8008
PP1003	RAL 1003	PP4002	RAL 4002	PP6022	RAL 6022	PP8011	RAL 8011
PP1004	RAL 1004	PP4003	RAL 4003	PP6024	RAL 6024	PP8012	RAL 8012
PP1005	RAL 1005	PP4004	RAL 4004	PP6025	RAL 6025	PP8014	RAL 8014
PP1006	RAL 1006	PP4005	RAL 4005	PP6026	RAL 6026	PP8015	RAL 8015
PP1007	RAL 1007	PP4006	RAL 4006	PP6027	RAL 6027	PP8016	RAL 8016
PP1011	RAL 1011	PP4007	RAL 4007	PP6028	RAL 6028	PP8017	RAL 8017
PP1012	RAL 1012	PP4008	RAL 4008	PP6029	RAL 6029	PP8019	RAL 8019
PP1013	RAL 1013	PP4009	RAL 4009	PP6032	RAL 6032	PP8022	RAL 8022
PP1014	RAL 1014	PP4010	RAL 4010	PP6033	RAL 6033	PP8023	RAL 8023
PP1015	RAL 1015	PP5000	RAL 5000	PP6034	RAL 6034	PP8024	RAL 8024
PP1016	RAL 1016	PP5001	RAL 5001	PP7000	RAL 7000	PP8025	RAL 8025
PP1017	RAL 1017	PP5002	RAL 5002	PP7001	RAL 7001	PP8028	RAL 8028
PP1018	RAL 1018	PP5003	RAL 5003	PP7002	RAL 7002	PP9001	RAL 9001
PP1019	RAL 1019	PP5004	RAL 5004	PP7003	RAL 7003	PP9002	RAL 9002
PP1020	RAL 1020	PP5005	RAL 5005	PP7004	RAL 7004	PP9003	RAL 9003
PP1021	RAL 1021	PP5007	RAL 5007	PP7005	RAL 7005	PP9004	RAL 9004
PP1023	RAL 1023	PP5008	RAL 5008	PP7006	RAL 7006	PP9005	RAL 9005
PP1024	RAL 1024	PP5009	RAL 5009	PP7008	RAL 7008	PP9006	RAL 9006
PP1027	RAL 1027	PP5010	RAL 5010	PP7009	RAL 7009	PP9007	RAL 9007
PP1028	RAL 1028	PP5011	RAL 5011	PP7010	RAL 7010	PP9010	RAL 9010
PP1032	RAL 1032	PP5012	RAL 5012	PP7011	RAL 7011	PP9011	RAL 9011
PP1033	RAL 1033	PP5013	RAL 5013	PP7012	RAL 7012	PP9016	RAL 9016
PP1034	RAL 1034	PP5014	RAL 5014	PP7013	RAL 7013	PP9017	RAL 9017
PP2000	RAL 2000	PP5015	RAL 5015	PP7015	RAL 7015	PP9018	RAL 9018
PP2001	RAL 2001	PP5017	RAL 5017	PP7016	RAL 7016	RP0002	EDELWEISS
PP2002	RAL 2002	PP5018	RAL 5018	PP7021	RAL 7021	RP0003	PERGAMON
PP2003	RAL 2003	PP5019	RAL 5019	PP7022	RAL 7022	RP0004	CAMEE
PP2004	RAL 2004	PP5020	RAL 5020	PP7023	RAL 7023	RP0005	JASMIJN
PP2008	RAL 2008	PP5021	RAL 5021	PP7024	RAL 7024	RP0006	NATUUR
PP2009	RAL 2009	PP5022	RAL 5022	PP7026	RAL 7026	RP0008	BAHAMA'S
PP2010	RAL 2010	PP5023	RAL 5023	PP7030	RAL 7030	RP0012	MANHATTAN
PP2011	RAL 2011	PP5024	RAL 5024	PP7031	RAL 7031	RP0013	EGEÏSCHE ZEE
PP2012	RAL 2012	PP6000	RAL 6000	PP7032	RAL 7032	RP0021	KEY WEST
PP3000	RAL 3000	PP6001	RAL 6001	PP7033	RAL 7033	RP0023	WHISPER BLAUW
PP3001	RAL 3001	PP6002	RAL 6002	PP7034	RAL 7034		
PP3002	RAL 3002	PP6003	RAL 6003	PP7035	RAL 7035		
PP3003	RAL 3003	PP6004	RAL 6004	PP7036	RAL 7036		
PP3004	RAL 3004	PP6005	RAL 6005	PP7037	RAL 7037		
PP3005	RAL 3005	PP6006	RAL 6006	PP7038	RAL 7038		
PP3007	RAL 3007	PP6007	RAL 6007	PP7039	RAL 7039		
PP3009	RAL 3009	PP6008	RAL 6008	PP7040	RAL 7040		
PP3011	RAL 3011	PP6009	RAL 6009	PP7042	RAL 7042		
PP3012	RAL 3012	PP6010	RAL 6010	PP7043	RAL 7043		
PP3013	RAL 3013	PP6011	RAL 6011	PP7044	RAL 7044		
PP3014	RAL 3014	PP6012	RAL 6012	PP7045	RAL 7045		
PP3015	RAL 3015	PP6013	RAL 6013	PP7046	RAL 7046		
PP3016	RAL 3016	PP6014	RAL 6014	PP7047	RAL 7047		
PP3017	RAL 3017	PP6015	RAL 6015	PP8000	RAL 8000		
PP3018	RAL 3018	PP6016	RAL 6016	PP8001	RAL 8001		
PP3020	RAL 3020	PP6017	RAL 6017	PP8002	RAL 8002		
PP3022	RAL 3022	PP6018	RAL 6018	PP8003	RAL 8003		

delivery time

stock Radson : available from stock
on demand : please contact Radson

General conditions of sale and delivery

Unless otherwise confirmed by us in writing, the conditions stated below shall apply to every sale or delivery, even if they deviate from the buyer's general conditions of purchase. Through his order the buyer accepts these conditions irrevocably.

1. Orders, conditions of delivery and any other provisions or descriptions apply only if the RETTIG BELGIUM NV has explicitly accepted them in writing. If the RETTIG BELGIUM NV when making an offer has stipulated a period for the acceptance thereof, the agreement will be deemed to have been concluded when the buyer has, prior to the expiry of this period, sent a notice in writing that he accepts the offer, on the understanding that an agreement has been concluded when this notice has not come in within one week after the expiry of this period. Price lists, catalogues and models are made available only by way of documentation; they can never bind us and may be changed by us without any prior notice. The models and catalogues remain the property of the RETTIG BELGIUM NV. The RETTIG BELGIUM NV will be bound only by obligations indicated by its agents, representatives and non-manual workers if it has confirmed these.
2. Change in or cancellation of the order. These will not be considered anymore if the manufacture of the ordered material has already begun.
3. Delivery. Our delivery dates stated in the order confirmations indicate when the goods will presumably leave our firm. They are given by way of information only and are adhered to as closely as possible. Late delivery, if any, must not give rise to cancellation of the sale or refusal of the order and can in no way oblige the RETTIG BELGIUM NV to damages.
4. The sale is deemed to have taken place in Zonhoven at our firm. The goods are transported at the risk and responsibility of the buyer, in the event of delivery carriage paid. When the RETTIG BELGIUM NV undertakes the transport of the goods, delivery will take place at the entrance to the construction sites. The moving of the goods by the personnel of the RETTIG BELGIUM NV, in the workshops or at the site of the buyer, or the lifting thereof to higher floors will take place fully at the risk and the responsibility of the buyer. Any complaint must be reported to the carrier upon the delivery and must be confirmed by registered letter to the RETTIG BELGIUM NV within 48 hours. No complaint whatsoever shall entitle the buyer to delay the payment or to reduce the amount thereof.
5. Cases of force majeure, including damage to the furnishings and fittings, accidents to persons, strike, war, negligence of the suppliers, lack of or delay in the transport, etc., due to which the delivery is obstructed or delayed, discharge the RETTIG BELGIUM NV of any responsibility and entitle it to renounce its obligations fully or partially without the buyer being able to claim any damages.
6. Transport. All our prices have been calculated for purchase at the factory warehouses, if a special packaging (crate) is explicitly desired, this packaging will be charged. This special packaging will be taken back if an agreement about this is concluded in advance.
7. Retention of title. The goods will remain the property of the seller until the buyer has paid the due purchase price, increased by all costs, charges and compensations, such as are included in the general and/or special conditions which govern the sale, resulting from late payment; even if the goods have been processed. Once the goods have been delivered, the buyer will bear all risks of loss and destruction. For Belgium we refer to article 491 of the Penal Code, of which the text reads as follows : Article 491 : "Anyone who, to the disadvantage of someone else, fraudulently mis-appropriates or wastes goods, monies, merchandise, bills, documents of any nature whatsoever which imply or give rise to an obligation or a discharge of debt and which have been handed over to him under the obligation to return them or to use or apply them for a specific purpose, will be punished with imprisonment of one month to five years and with a pecuniary penalty of € 0,65 to € 12,50. In addition, the culprit can be sentenced to deprivation of rights pursuant to article 33."
8. Payment. The RETTIG BELGIUM NV reserves its right to demand a security from the buyer to fulfil his obligations, even after partial delivery of the goods. If the buyer refuses to give the requested security, the RETTIG BELGIUM NV will be entitled to suspend the execution of the order or its balance. The invoices of the RETTIG BELGIUM NV are payable at Zonhoven and must be paid cash on delivery, unless otherwise agreed. Any discount or other costs shall be borne by the buyer, in the event of late payments the RETTIG BELGIUM NV is entitled to charge interest on overdue payments, calculated on the basis of the rate of discount of the National Bank of Belgium, for non-accepted trade securities, increased by 1 %; after registered

notice of default the invoice amount will additionally be increased by 20 % on account of compensation. In the event the buyer does not satisfy the agreed payment conditions, the RETTIG BELGIUM NV will be entitled to postpone further deliveries and to cancel current deliveries without notification. The non-payment on its due date of one single invoice will render the due balance of all the other invoices, even if not yet due, immediately due and payable by operation of law. When the buyer fails to fulfil his obligations, the sale will be dissolved by operation of law and without notice of default. The seller's declaration by registered letter of his intention to do this will suffice for this.

9. Taking back and/or cancellation of radiators is possible only after mutual agreement and only for radiators featuring on the latest valid stock list. The percentage of the compensation will be determined by our departments in consultation with the customer.
10. Goods returned. In addition to the conditions in case of cancellations the following conditions must be satisfied :
 - all goods returned must be provided with a label stating name and address of the customer to whom they have been invoiced by us.
 - in addition, the shipment must take place carriage paid. Collection by the carrier of the RETTIG BELGIUM NV can be charged.
 - only after an investigation will compensation, if any, be paid by us.
11. Postponed delivery. If the delivery of ordered materials is postponed by the buyer or placed on call, the RETTIG BELGIUM NV will reserve the right, after expiry of three months, either to demand immediate payment of the purchase price, or to cancel the contract of sale, or to charge the materials at the price valid on the day of delivery, one or two things without any reminder being required and without prejudice to the right to sue the buyer for damage or interest.
12. Guarantee. For installations starting from 1st of January, our radiators are guaranteed for a period of 10 years against all manufacturing defects when they are used in normal conditions and for a heating system with hot water. This guarantee does not apply to defects caused by installation errors or factors external to the radiators (water quality, oxygen-permeable pipes, ...). In the event of raw material defects or manufacture defects recognised by the RETTIG BELGIUM NV, the buyer will be entitled only to demand repair or replacement of the defective parts, It is explicitly agreed that the RETTIG BELGIUM NV is not obliged to any damages, either for personal accidents or for damage to other goods or for loss of profit.
13. Competent court. In case of disputes, the Courts of Hasselt - Belgium or the Courts of the domicile of the buyer, at the option of the seller, shall have exclusive jurisdiction.

The prices mentioned in € are valid from **May 1st, 2011** and are **excluding VAT**.

This document is not binding.

RETTIG BELGIUM NV reserves the right to change the products without prior notice.

www.radson.com - info@radson.be



www.radson.com

Vogelsancklaan 250 - B-3520 Zonhoven
T. +32 (0)11 81 31 41 - F. +32 (0)11 81 73 78

RADSON 
clever heating solutions